

PZL POLE H30

Code 000266

H30cm anchor device certified for EN 795 and CEN/TS 16415 type A and C. Hot dip galvanized steel. Base 40cm x 16cm for wooden beam with 8 bores ideals for threaded bars or wood screws.

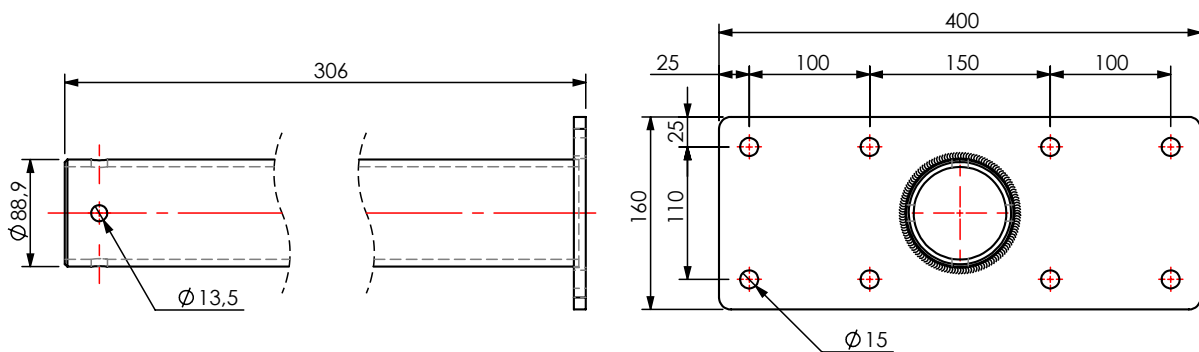

Material	Hot-dip galvanized S235
Dimensions (mm)	305 x 400 x 160
Weight (kg)	9,47
CN code	73269098
EAN code	8055773300828

STANDARDS



	A	C
UNI EN 795:2012	1	1
UNI 11578:2015	-	4
CEN/TS 16415:2013	2	4

LENGTH	min 5 max 120
SPAN	min 5 max 20

Discover the product line:

