

## PZI POLE H50

Code 000185

H50cm anchor device certified for EN 795 and CEN/TS 16415 type A and C. Hot dip galvanized steel. Sloped fixing base 30cm x 30cm with 4 slots for a maximum comfort during installation.

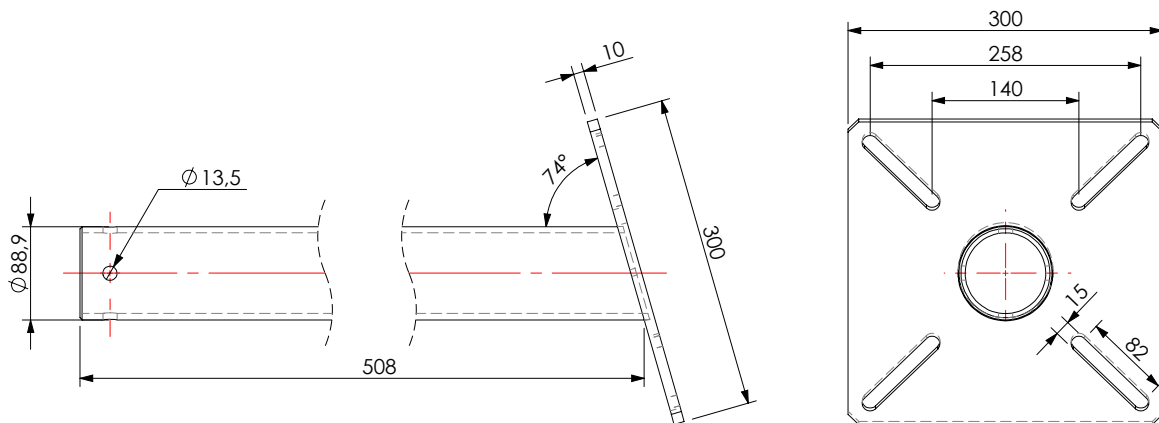

<b>Material</b>	Hot-dip galvanized S235
<b>Dimensions (mm)</b>	300 x 546 x 291
<b>Weight (kg)</b>	14,33
<b>CN code</b>	73269098
<b>EAN code</b>	8055773300767

### STANDARDS



	A	C
UNI EN 795:2012	1	1
UNI 11578:2015	-	4
CEN/TS 16415:2013	2	4

<b>LENGTH</b>	min 5 max 120
<b>SPAN</b>	min 5 max 20

Discover the product line:

